

# LEF SYSTEM DOOR STATION

Model;

**LE-DL**

(Surface-mount door station)

## INSTRUCTIONS

**1**

### NAMES AND FUNCTIONS

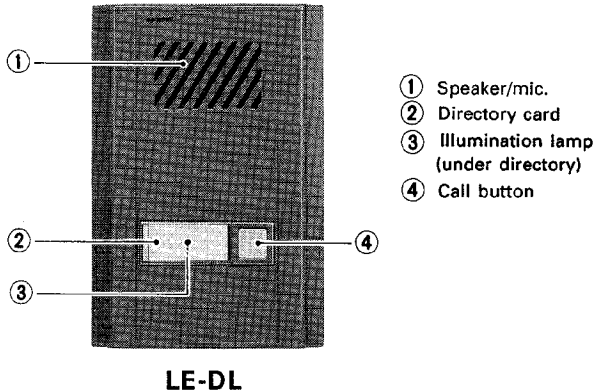

#### Mounting accessories;



Screws (x 2)



Wood screws (x 2)



Opener



Lamp

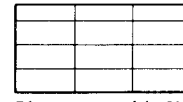

Directory card (x 9)

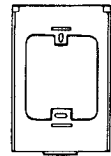

Mounting bracket

**2**

### FEATURES

- \* LE-DL door station can work with Aiphone LEF, LEF-B Loudspeaker Intercom Systems.
- \* Surface-mount with rigid aluminum panel.
- \* Call-acknowledged tone heard at door station.
- \* Illumination from under directory card.

**3**

### BEFORE YOU INSTALL AND OPERATE THE EQUIPMENT – Prohibitions and precautions –

#### Operation;

- ① Momentarily depress CALL button on LE-DL door station to signal a room station(s).  
Call tone sounds while call button is being depressed. After room station replies, communicate handsfree.

#### Installation;

- ② DO NOT CONNECT ANY TERMINAL ON ANY UNIT TO AC POWER LINES.
- ③ When you mount LE-DL door station in place of existing bell or chime, be sure to disconnect wires from the present transformer.
- ④ Select the installation locations that would not be exposed to temperature/humidity extremes, water/oil, dust, iron dust, inflammable and chemical products, etc.

#### Maintenance;

- ⑤ Clean your LE-DL with a soft cloth dampened with neutral household cleanser.
- ⑥ Do not splash water on the door station by hose, etc.
- ⑦ Filling in directory and lamp replacement:

As shown, the transparent cover can be removed, using a supplied opener.

Fill in directory and slide the cover back to place.

To replace the lamp, turn off the system's power supply and pull the lamp off from the pin terminals, using a pincette, etc. Be careful not to touch with other components.

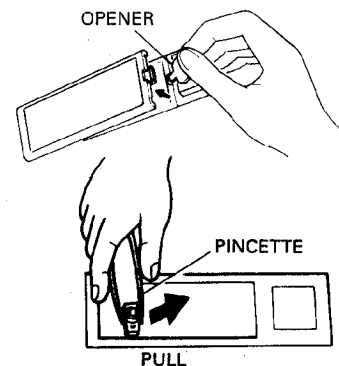

# 4 INSTALLATION

## (1) Actual terminal location;

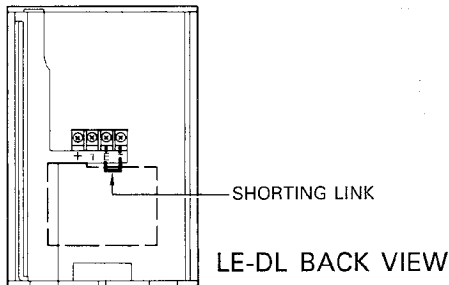

- +** **-** : for power supply of lamp.
- 1** : Connect to No. terminal of room masters.
- E** : Connect to E terminal of room masters.

## (2) Wall-mounting installation;

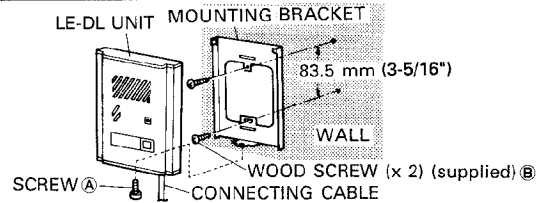

1. Remove a screw **A** on bottom of LE-DL.
2. Attach the mounting bracket directly to wall with the supplied wood screws **B**, or to single-gang box with the supplied screws.
3. After wiring, reattach LE-DL unit to the mounting bracket.

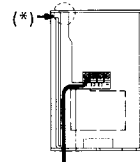

Connecting cable can be passed from either top or bottom of the chassis.

(\*) Cut off the part by nipper, etc. for cable inlet.

# 5 WIRING DIAGRAM

## (1) SINGLE-MASTER SYSTEM;

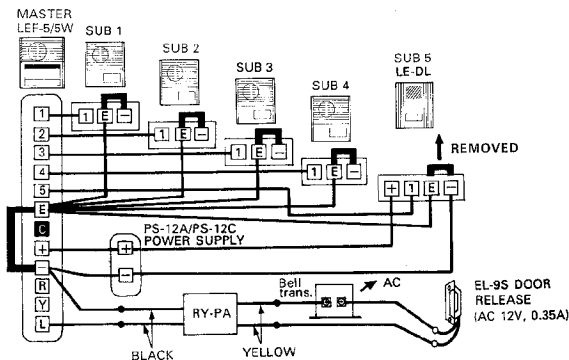

Sub 1 ~ 4 can either be LE-A, LE-AN, LE-D or LE-DA. Shorting link on LEF master & subs must remain attached, except on LE-DL.

## (2) INTERMIXED SYSTEM;

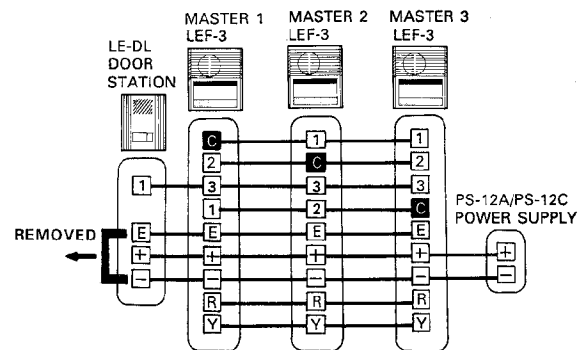

On all the stations, remove a shorting link.

# 6 SPECIFICATIONS

* Power source:	Supplied by PS-12A or PS-12C power supply (LEF system).									
* Calling:	Pressing call button signals the room station(s) by electronic mono tone.									
* Wiring distance:	Diameter	0.5 mm	0.65 mm	0.8 mm	1.0 mm	AWG	24AWG	22AWG	20AWG	18AWG
	Distance	120 m	200 m	300 m	480 m	Distance	400'	650'	1000'	1600'
* Dimensions (H x W x D) & weight:	175 x 120 x 25 (mm) (6-7/8" x 4-3/4" x 1"). Approximately 430g (0.9 lbs.).									

## WARRANTY

Aiphone warrants its products to be free from defects of material and workmanship under normal use and service for a period of one year after delivery to the ultimate user and will repair free of charge or replace at no charge, should it become defective upon which examination shall disclose to be defective and under warranty. Aiphone reserves unto itself the sole right to make the final decision whether there is a defect in materials and/or workmanship; and whether or not the product is within the warranty.

This warranty shall not apply to any Aiphone product which has been subject to misuse, neglect, accident, or to use in violation of instructions furnished, nor extended to units which have been repaired or altered outside of the factory.

This warranty does not cover batteries or damage caused by batteries used in connection with the product.

This warranty covers bench repairs only, and any repairs must be made at the shop or place designated in writing by Aiphone. Aiphone will not be responsible for any costs incurred involving on site service calls.

Aiphone Co., Ltd., Nagoya, Japan  
Aiphone Corporation, Bellevue, WA, USA

COMMUNICATION SYSTEMS  
**AIPHONE**  
HOME, BUSINESS, INDUSTRY